

STAR FLEET BATTLES

CAPTAIN'S EDITION BASIC SET

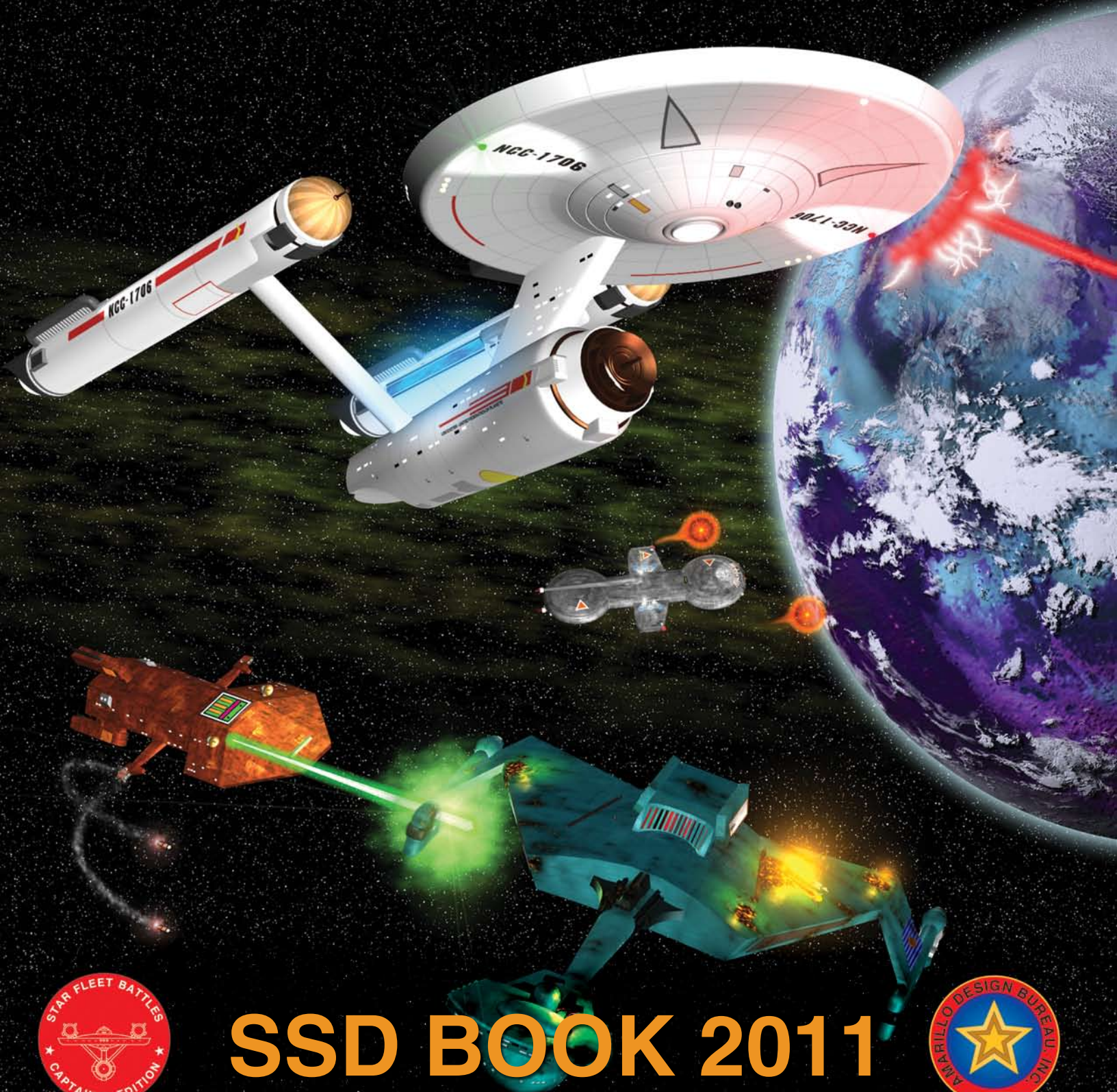

SSD BOOK 2011



STAR FLEET BATTLES

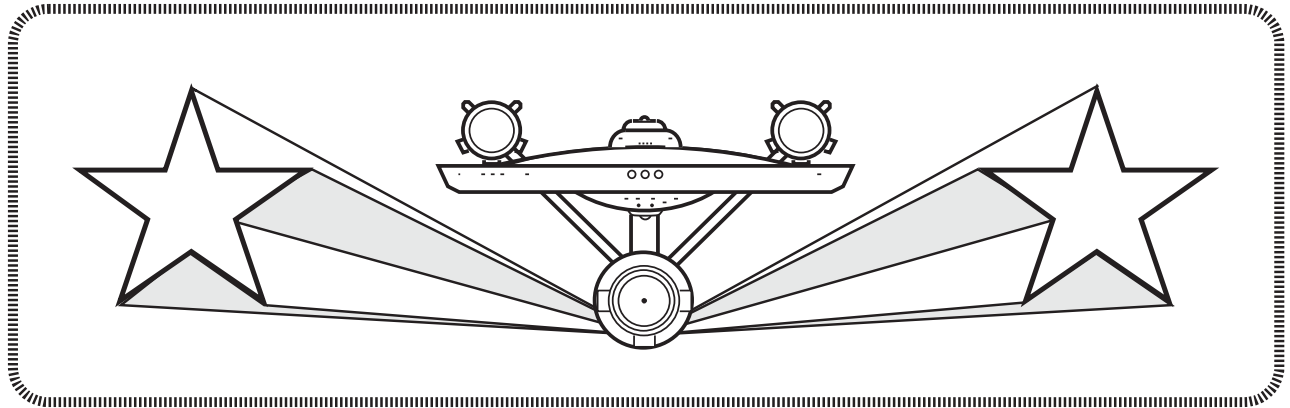

CAPTAIN'S BASIC SET SSD BOOK 2011



TABLE OF CONTENTS

RULE #	SSD	PAGE #	RULE #	SSD	PAGE #
GENERAL UNITS			ROMULAN SHIPS		
R1.1	Starbase (SB)	24-25	R4.2	Romulan Warbird Cruiser (WB)	19
R1.2	Battle Station (BATS)	23	R4.3	Romulan War Eagle Cruiser (WE)	20
R1.3	Base Station (BS)	26	R4.4	Romulan KR Cruiser (KR)	21
R1.5	Small Freighter (F-S)	3	R4.5	Romulan K5R Frigate (K5R)	22
R1.6	Large Freighter (F-L)	4	KZINTI SHIPS		
R1.7	Federation Large Q-Ship (L-Q)	5	R5.2	Kzinti Strike Cruiser (CS)	33
R1.7	Federation Small Q-Ship (S-Q)	6	R5.3	Kzinti Battlecruiser (BC)	34
R1.7	Klingon Large Q-Ship (L-Q)	7	R5.4	Kzinti Command Cruiser (CC)	35
R1.7	Klingon Small Q-Ship (S-Q)	8	R5.5	Kzinti Light Cruiser (CL)	36
R1.7	Gorn Large Q-Ship (L-Q)	9	R5.6	Kzinti Carrier (CV)	37
R1.7	Gorn Small Q-Ship (S-Q)	10	R5.7	Kzinti Strike Carrier (CVS)	38
R1.13	Small Auxiliary Carrier (AxCVL)	2	R5.8	Kzinti Frigate (FF)	39
FEDERATION SHIPS			R5.20	Kzinti Escort Frigate (EFF)	40
R2.2	Federation Dreadnought (DN)	11	R5.20A	Kzinti Aegis Frigate (AFF)	40
R2.3	Federation Command Cruiser (CC)	12	GORN SHIPS		
R2.4	Federation Heavy Cruiser (CA)	13	R6.2	Gorn Heavy Cruiser (CA)	41
R2.5	Federation (Old) Light Cruiser (CL)	14	R6.3	Gorn Light Cruiser (CL)	42
R2.6	Federation Destroyer (DD)	15	R6.4	Gorn Destroyer (DD)	43
R2.7	Federation Scout (SC)	16	R6.4	Gorn Fleet Destroyer (DDF)	44
R2.8	Federation Fleet Tug (TUG)	17	R6.19	Gorn Battlecruiser (BC)	41
R2.10	Federation Battle Tug (BT)	18	THOLIAN SHIPS		
R2.9-11	Federation Pods	48	R7.2	Tholian Patrol Corvette (PC)	45
KLINGON SHIPS			R7.3	Tholian Improved Patrol Corvette (PC+)	46
R3.2	Klingon C9 Dreadnought (C9)	27	ORION SHIP		
R3.3	Klingon C8 Dreadnought (C8)	28	R8.2	Orion Raider Cruiser (CR)	47
R3.4	Klingon D7 Battlecruiser (D7)	29			
R3.5	Klingon D6 Battlecruiser (D6)	30			
R3.6	Klingon F5 Frigate (F5)	31			
R3.7	Klingon E4 Escort (E4)	32			

KLINGON D7 BATTLECRUISER

YS:135
DK:7
EX:19
CR:8



DAM CON

4
4
2
2
2
0

SHIELD #2

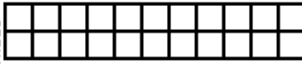

SHIELD #6

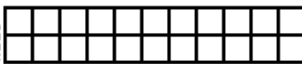

SENSOR

6
6
5
3
1
0

SCANNER

0
0
1
3
5
9

EX DAM

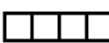

CNTR

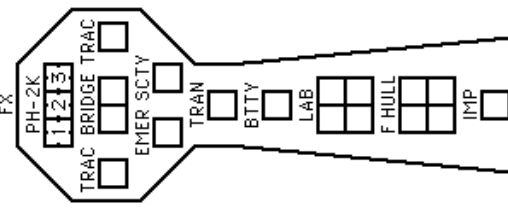

SHIELD #3



SHIELD #5



SHIELD #4



ADMINISTRATIVE SHUTTLES

IDENT	HIT POINTS	NOTES
	10	A A
	20	A A
	30	A A
	40	

HIT POINTS MARKED "A" ARE ONLY USED WHEN OPERATING ADVANCED SHUTTLES AFTER Y179; SEE (J17.0) IN MODULE J2.

TRANSPORTER BOMBS

--	--	--	--	--	--	--	--	--	--

PROBES

--	--	--	--	--	--	--	--	--	--

DERFACS INSTALLED AS PART OF THE B-REFIT IN Y165.

DRONE RACKS

--	--	--	--	--	--	--	--	--	--

SHIP HAD TYPE-A DRONE RACKS (ONE RELOAD) UNTIL THE Y175 REFIT, WHICH CONVERTED THESE TO TYPE-B DRONE RACKS (2 RELOADS) CAN FIRE ONE DRONE EACH TURN. B-REFIT CAN FIRE ONE DRONE FROM EACH RACK EACH TURN.

TYPE I OFFENSIVE PHASER TABLE

DIE RANGE	4-9	16-26	51-75										
ROLL 0	1	2	3	4	5	6	7	8	9	15	25	50	75
1	9	8	7	6	5	5	4	3	2	1	1	1	1
2	8	7	6	5	5	4	3	2	1	1	0	0	0
3	7	5	5	4	4	4	3	1	0	0	0	0	0
4	6	4	4	4	4	3	2	0	0	0	0	0	0
5	5	4	4	4	3	2	0	0	0	0	0	0	0
6	4	4	3	3	2	2	0	0	0	0	0	0	0

ANTI-DRONE TABLE

RANGE	0	1	2	3	4+
HIT*	-	1-2	1-3	1-4	-

ANTI-DRONES

1																			
---	--	--	--	--	--	--	--	--	--	--	--	--	--	--	--	--	--	--	--

ADD ADDED BY THE B-REFIT. HAD SIX ROUNDS PRIOR TO Y175, 12 THEREAFTER.

TYPE III DEFENSE PHASER

DIE RANGE	4-9	16-26	51-75							
ROLL 0	1	2	3	4	5	6	7	8	9	15
1	4	4	4	3	1	1	1	1	1	1
2	4	4	4	2	1	0	0	0	0	0
3	4	4	4	1	0	0	0	0	0	0
4	4	4	4	3	0	0	0	0	0	0
5	4	4	3	2	0	0	0	0	0	0
6	3	3	1	0	0	0	0	0	0	0

TYPE II PHASER TABLE

DIE RANGE	4-9	16-31	51-75										
ROLL 0	1	2	3	4	5	6	7	8	9	15	30	50	75
1	6	5	4	3	2	1	1	1	1	1	1	1	1
2	6	5	4	2	1	1	0	0	0	0	0	0	0
3	6	4	4	1	1	0	0	0	0	0	0	0	0
4	5	4	4	3	1	0	0	0	0	0	0	0	0
5	5	4	3	3	0	0	0	0	0	0	0	0	0
6	5	3	3	3	0	0	0	0	0	0	0	0	0

DISRUPTOR TABLE

RANGE	0	1	2	3-4	5-8	9-15	16-22	23-30
HIT (STD)	NA	1-5	1-5	1-4	1-4	1-4	1-3	1-2
HIT (UIM)	NA	1-5	1-5	1-4	1-4	1-4	1-4	1-2
HIT (DERFACS)	NA	1-5	1-5	1-4	1-4	1-4	1-3	1-3
HIT (OVERLOAD)	1-6	1-5	1-5	1-4	1-4	NA	NA	NA
HIT (OL/UIM)	1-6	1-5	1-5	1-5	1-5	1-5	1-5	NA
DAMAGE, STD	0	5	4	4	3	3	2	2
DAMAGE, OULD	10	10	8	8	6	0	0	0

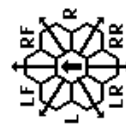

FA = LF + RF
FX = L + LF + RF + R
MOVEMENT COST = 1
HET COST = 5
EM COST = 6

SHADED BOXES ARE ADDED BY THE B-REFIT.
PHASER-2s MARKED "K" ARE CHANGED TO PHASER-1s ON THE K-REFIT.
THE FORWARD PHASERS CAN FIRE INTO THE ROW OF HEXES EXTENDING DIRECTLY BEHIND THE SHIP.
SEE (D2.33).

WING PHASERS ALSO HAVE SPECIAL ARCS; SEE (D2.32).