

a **CAR WARS**® supplement

CAR WARS

**MILITARY
VEHICLE
GUIDE**



By Craig Sheeley

STEVE JACKSON GAMES

THE BIG GUNS



If you liked the military gadgets in *Uncle Al's Catalog from Hell* – or if you went whole-hog and bought *Car Wars Tanks* – here's the book you've been waiting for.

The *Military Vehicle Guide* contains over 80 different military vehicles and variants – tanks, armored cars, helicopters and other aircraft, and more.

And it includes over 150 different full-color *Car Wars* counters. Each counter includes the wrecked vehicle on the back. For the most-used vehicles, there are several counters – so you can create your own realistic military force.

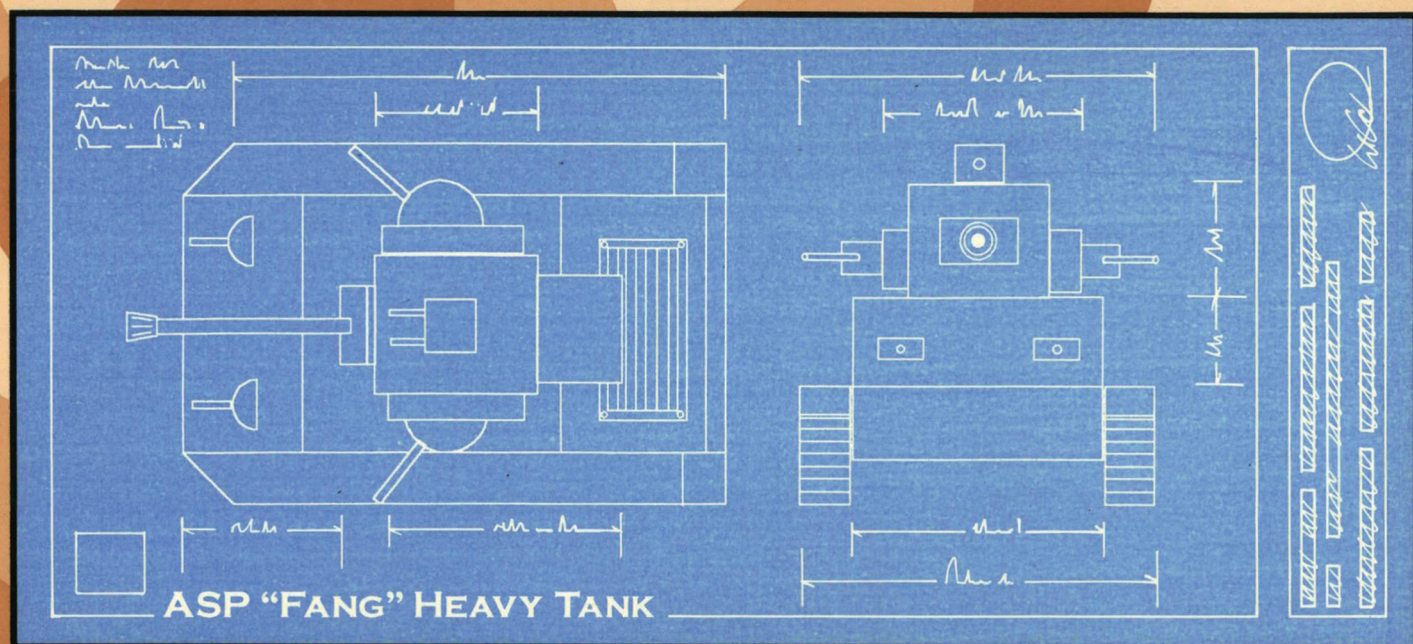

There's also a description of the new Central Missouri Commercial Combat Zone, located in and around old Fort Leonard Wood, where national forces, mercenaries and even corporate armies slug it out for the TV audience.

This is a Car Wars supplement. You need Car Wars and either Uncle Al's Catalog from Hell or Car Wars Tanks to play.

Written by Craig Sheeley
Edited by Jeff Koke
Counters and Vehicle Diagrams by Michael Scott

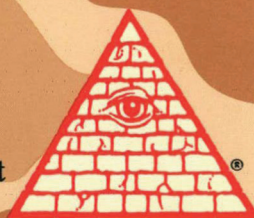

STEVE JACKSON GAMES



0 80742 07151 3

ISBN 1-55634-255-1

SJG01295 7151

Made in U.S.A.

CAR WARS

MILITARY VEHICLE

GUIDE

Written by **Craig Sheeley**

Edited by **Jeff Koke**

Counters and Vehicle Diagrams by **Michael Scott**

Cover design by **Carl Anderson**

Vehicle Checking by **Todd MacDermid and Brian Morrison**

Jeff Koke, Managing Editor

Loyd Blankenship, Product Development Manager

Carl Anderson, Production Manager

Production by **Carl Anderson and Lynette Alcorn**

Page Layout and Typography by **Monica Stephens and Jeff Koke**

Kerry Havas, Print Buyer

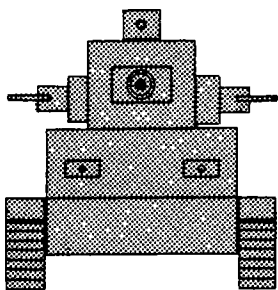

Playtesters: **John Freiler, Bruce Lam, Robert Rapplean, Randall D. Wheat**

Counters

Aircraft

All aircraft counters are at air-to-air scale, as per *Aeroduel*, p. 20.

Chickens

Chickens have 1 HP and move as a ped. They can fly onto or over any obstacle not more than 1" high or 2" across. Their speed is the same in the air as on the ground. Chickens are at -6 to target due to their size. They cannot be armed or armored. They taste great fried, with dumplings or baked in herbs.

Contents

Introduction	2
Abbreviations	3
Central Missouri Combat Zone	4
Motorcycles	7
Tricycles	12
Cars	15
Trucks	21
Hovercraft	24
Boats	29
Helicopters	34
Aircraft	41
Armored Cars	51
Armored Fighting Vehicles	55

Car Wars, Autoduel, Illuminati, GURPS, and the all-seeing pyramid are registered trademarks and AADA and the AADA logo are trademarks of Steve Jackson Games Incorporated. All names of other products published by Steve Jackson Games Incorporated are registered trademarks or trademarks of Steve Jackson Games Incorporated, or are used under license. "Jeep" is a registered trademark of Chrysler Corporation.

Car Wars Military Vehicle Guide is copyright © 1992 by Steve Jackson Games Incorporated. All rights reserved. Printed in the U.S.A.

ISBN 1-55634-225-1

1 2 3 4 5 6 7 8 9 10

STEVE JACKSON GAMES

INTRODUCTION

Military vehicles differ from most civilian duellist vehicles in that they are usually designed as single-purpose vehicle beds, much like medium commercial vehicles. All-purpose vehicles like those popular in the civilian market are the exception in military service. Instead, a military vehicle is usually devoted to one function, to the detriment of other functions.

For example, the M-H25 Mobile Hovercraft Artillery Support Vehicle (see p. 27) carries artillery rockets, and that's *all* it carries. In a similar mode, the "Jeep" General-Purpose Small Transport (see p. 15) carries only a single pintle-mount MG, with the rest of the vehicle's space devoted to cargo and passengers. That's not much gunnery when matched against comparably-sized autoduelling vehicles.

In fact, most military vehicles aren't designed for combat. To be sure, AFVs and other front-line combat vehicles mount weaponry capable of destroying a car with a single shot, but the support and rear-area vehicles are normally poorly-armed and -armored. This is because they tend to operate in groups, or with other more heavily-armed vehicles acting as escorts. A truck convoy usually has a small helicopter and a couple of duellist-class vehicles riding shotgun, as well as the HMGs mounted on the trucks.

Classifications

Military vehicles usually fall into one of the following categories of function:

Air Superiority: An aircraft built for the specific purpose of shooting down other aircraft and maintaining or contesting air superiority over the battlefield.

Anti-Aircraft: A vehicle hauling AA weapons – rapid-fire guns, SAMs, etc. – and using them to guard other vehicles from aircraft.

Armor-Hunter (AH): A vehicle mounting heavy stand-off offensive weaponry and relatively thin armor. Its purpose is the destruction of Battle Tanks and other heavily-armored targets.

Armored Personnel Carrier (APC): A vehicle built to transport troops into hostile environments, usually equipped with light weaponry, allowing them to support their troops. An APC sacrificing troop capacity and mobility in favor of heavier weaponry is called an Infantry Fighting Vehicle (IFV).

Attack: Mostly applied to helicopters, this indicates a vehicle that is armed for both assault and anti-armor.

Assault: A fire-support vehicle mounting bombardment and light weaponry, intended for troop support and direct-fire attacks. It is lighter than a Battle Tank and mounts lighter weaponry.

Auxiliary: A catch-all classification encompassing any vehicle type not mentioned above. Most autoduelling vehicles used by military and paramilitary organizations fall into this category.

Battle Tank (MBT): A fully-tracked vehicle mounting heavy offensive armament and armor, capable of surviving long enough in an intense combat environment to deliver its offensive payload. These vehicles tend to mount one or two heavy weapons and several lighter weapons for anti-personnel/light vehicle use.

Cargo: A cargo-hauler, devoted to moving equipment and supplies from one spot to another.

Command: A vehicle specifically modified to function as a command and control center.

Engineering: A vehicle dedicated to engineering problems – removing obstacles, bridging gaps, and construction.

General Purpose: A vehicle that can be modified for various purposes – combat, transport, cargo, etc.

Patrol: A moderately-armed and -armored vehicle constructed for mobile perimeter patrol. Often it is indistinguishable from an autoduelling vehicle, and many autoduelling vehicles with upgraded equipment are used for this purpose.

Recon: A small, fast vehicle devoted to gathering battlefield intelligence. It is typically under-armed, depending on speed and stealth rather than on firepower.

Self-Propelled Artillery: A vehicle mounting artillery weapons, either mortars, guns, cruise missiles or rockets. Its mission is to provide artillery fire support, not to engage the enemy directly.

Transport: A vehicle for troop transport, off the battlefield, with minimal weaponry and emphasis on troop capacity. Transports often double as cargo vehicles.

Vehicle Types

The vehicles listed in this guide are grouped according to vehicle chassis type rather than function: Motorcycles, Trikes, Cars, Trucks, Hovercraft, Boats, Helicopters, Aircraft, Armored Cars, and Armored Fighting Vehicles (fully-tracked AFVs). Each vehicle has its specific function noted.

Note that the illustration of each vehicle is for silhouette recognition only; they are not to any particular scale, even within each vehicle type.

Who Makes These Vehicles?

Various vehicle manufacturers around the world, and particularly in North America, manufacture and sell military and mil-spec vehicles. Some vehicles are made under strict contract to specific military organizations, with the understanding that those vehicles will not be made for or sold to any other person or organization. Some are made in conjunction with specific military organizations and marketed to interested buyers with the military's blessing. The rest are designed by the manufacturers for direct sale.

Almost every manufacturer of autoduelling equipment builds military equipment as well. The markup on military vehicles is higher and the market is not as fickle as the autoduelling market; these factors attract manufacturers. Such brand-names as Nippon Motors, Fnord, Alamo Arms, H&K&P, and Generic Motors can be found in the military marketplace, as well as scores of smaller, more specialized firms.

Who Buys Them?

Military vehicles are not sold to every customer who walks into a manufacturer's showroom. They are sold to accredited armies, both governmental and corporate, and to individuals who have excellent credit references and the wherewithal to pay for the expensive machines. Bargains can be had by ordering bulk shipments of vehicles, but this is usually restricted to a few types of vehicle per army. The U.S. Armed Forces and the Texan Armed Forces are exceptions to this rule, waging an economic war based on the acquisition of equipment. Aside from these two military giants, most military vehicle purchasers are corporations interested in security, defensive postures and equipment for their private gladiatorial armies.

Some "mercenary" commercial armies purchase military vehicles. They are few, generally under-equipped, and carefully watched by the Federal and the Free Oil States' governments.

Where Can These Vehicles Be Found?

Most of the time, military vehicles are kept close to their home bases. They're too expensive to use for normal patrol and convoy duties; normal autoduelling vehicles can handle those functions. The only good view of military vehicles the average citizen is likely to have is on the nightly documentary program *Brute Firepower*, Death TV's most popular program (Channel 37 on the Sat-Link global communications system), or in action footage from Commercial Combat Zone engagements. This is to the average citizen's benefit, because even the most lightly-armored military vehicles are virtually immune to the light machine-guns carried by most citizens' vehicles. Occasionally, citizens might bump into military convoys moving between bases and engagements, or get to see a military vehicle show.

In 2042, few people actually man and maintain military vehicles. During the late 20th century, the great armies of the world employed hundreds of thousands of soldiers who worked with such equipment on a daily basis. However, despite today's

smaller armies, more people than ever are familiar with military vehicles and combat, thanks to the subject's media popularity. Vid-shows like *Brute Firepower*, computer games and combat micros (virtual copies of military training micros) all contribute to the public's military education.

The favorite military medium is combat televiolence. Every week, commercial combat teams meet in actual battle, covered by scores of cameras, so the audience doesn't miss a second of the action. And through the wonder of instant replay and computerized intelligence processing, every firefight can be routed to the home audience, in slow motion. Intricate networks of carefully positioned cameras allow directorial staffs to overcome the old problem of action occurring while the cameras are elsewhere – and if there's too much action at once, the images are kept on file and shown during periods of inaction.

These battles are even more popular with broadcasters than professional autoduelling – a commercial battle may cost more to produce, but lasts much longer than the average autoduelling event, allowing more commercial time, and ultimately producing more income.

Abbreviations

GC – Gatling Cannon
 RFTG – Rapid Fire Tank Gun
 RGM – Radar Guided Missile
 HSRGM – High Speed Radar Guided Missile
 AAM – Air-to-Air Missile
 A(n) – Artillery Gun
 AFT – Auxiliary Fuel Tank
 AFV – Armored Fighting Vehicle
 APC – Armored Personnel Carrier
 AStab – Auto-Stabilizer
 CBR – Chemical, Biological, Radiological
 CCZ – Commercial Combat Zone
 Coax – Coaxial Mount
 FS – Flash Suppressor
 HLAW – Heavy LAW
 HS – Hot Smoke
 HSP – Hot Smoke Projector
 IFV – Infantry Fighting Vehicle
 IMG – Infantry Machine Gun
 IRRF – IR Laser Rangefinder
 IRSH – Infrared Shielding
 N₂O – Nitrous Oxide
 ABR – Armored Beer Refrigerator
 ABS – Antilock Braking System
 AC – Autocannon
 Accel. – Acceleration -
 AMP – Armored Minifridge
 AP Ammo – Anti-Personnel or Armor-Piercing Ammo
 APFSDS – Armor-Piercing Fin-Stabilized Discarding Sabot Warheads
 APPR – Anti-Power-Plant Rocket
 AR – Assault Rifle
 ATAD – Automatic Target Acquisition Device
 ATG – Anti-Tank Gun
 AVR – Anti-Vehicular Rifle
 B – Back
 B – Bomb
 BA – Body Armor
 BC – Blast Cannon
 BL – Back Left
 BP – Blast Points
 BR – Back Right
 BR – Bomb Rack
 CA – Component Armor
 CA Frame – Carbon-Aluminum Frame
 CACR – Coaxial Counter-Rotating Blade System
 CB – Cluster Bomb
 CBSS – Cloud Bomb
 CD – Chaff Dispenser
 CPS – Cost per Shot
 CTS – Cycle Turreted Sidecar
 d – die (6-sided)

D – Difficulty Rating
 DP – Damage Points
 DSP – Drop-Spike Plate
 DStG – Double-Barreled Shotgun
 DWM – Dual-Weapon Magazine
 ERIS – Encoded Remote Ignition System
 EWP – External Weapon Pod
 F – Front
 FCD – Flame Cloud Discharger
 FCE – Flame Cloud Ejector
 FCGS – Flame Cloud Gas Streamer
 FD – Flechette Discharger
 FDSP – Fake Drop-Spike Plate
 FE – Fire Extinguisher
 FG – Flechette Gun
 FL – Front Left
 FLDSP – Fake Large Drop-Spike Plate
 FOD – Flaming Oil Discharger
 FOJ – Flaming Oil Jet
 FP – Fireproof
 FR – Front Right
 FT – Flamethrower
 GE – Grenade Equivalent
 GG – Gauss Gun
 GL – Grenade Launcher
 GP – Gauss Pistol
 GR – Gauss Rifle
 GS1, GS2 – Gyroslugger
 GS – Gas Streamer
 HARM – Homing Anti-Radar Missile
 HAVR – Heavy AV Rifle
 HC – Handling Class
 HD – Heavy-Duty
 HD Ammo – High-Density Ammo
 HDCCD – Heavy-Duty Chaff Dispenser
 HDFCE – Heavy-Duty Flame Cloud Ejector
 HDFT – Heavy-Duty Flamethrower
 HDID – Heavy-Duty Ice Dropper
 HDOJ – Heavy-Duty Oil Jet
 HDPS – Heavy-Duty Paint Spray
 HDSS – Heavy-Duty Smokescreen
 HEAT – High-Explosive Anti-Tank Warheads
 HESH – High-Explosive Squash-Head Warheads
 HFOJ – Heavy Flaming Oil Jet
 HL – Heavy Laser
 HP – Heavy Pistol
 HR – Heavy Rocket
 HRSWC – Hi-Res Single-Weapon Computer
 HT Ammo – High-Temperature Ammo
 HXL – Heavy X-ray Laser
 IBA – Improved Body Armor
 IcD – Ice Discharger
 ID – Ice Dropper
 IFE – Improved Fire Extinguisher

IFF – Identification Friend or Foe
 Imp. – Improved
 IR – Infrared
 IRSS – Infrared Sighting System
 ISC – Improved Supercharger Capacitor
 ISH – Integrated Systems Helmet
 JD – Junk Dropper
 L – Laser
 L – Left
 LAW – Light Anti-tank Weapon
 LB – Long Barrel
 LBT – Light Battle Tank
 LDSP – Large Drop-Spike Plate
 LFT – Light Flamethrower
 LGL – Laser-Guidance Link
 LIG – Light Intensifier Goggles
 Light Amp – Light Amplification
 LL – Light Laser
 LLAW – Laser LAW
 LOF – Line of Fire
 LOS – Line of Sight
 LP – Light Pistol
 LR – Laser Rifle or Laser-Reflective
 LRF – Laser Rangefinder
 LrR – Light Rocket
 LTS – Laser Targeting Scope
 LV LAW – Laser V LAW
 M – Mortar
 MBT – Main Battle Tank
 MC – Magnetic Cannon
 MD – Minedropper
 MF – Mine-Flinger
 MFR – Multi-Fire Rocket Pod
 MG – Machine Gun
 ML – Medium Laser
 MML – Micromissile Launcher
 MMSD – Mechanical Memory Storage Device
 MNR – Mini Rocket
 MP – Machine Pistol
 MPG – Miles Per Gallon
 MPRL – Man-Portable Rocket Launcher
 MR – Medium Rocket
 NBC – Nuclear/Biological/Chemical
 NBC Shielding – Nuclear/Biological/Chemical Shielding
 OD – Oil Discharger
 OG – Oil Gun
 OJ – Oil Jet
 OR – Off-Road
 PCs – Platinum Catalysts
 PD – Paint Discharger
 PDG – Point-Defense Grenade
 PES – Portable Earth Station
 PFT – Portable Flamethrower
 PG – Paint Gun
 PMML – Portable Micromissile Launcher
 PR – Puncture Resistant
 PS – Paint Spray
 PU – Power Units

R – Radial
 R – Right
 R(n) – Artillery Rocket
 Rev. – Reversed
 REWP – Rocket EWP
 RGM – Radar-Guided Missile
 RL – Rocket Launcher
 RP – Rocket Platform
 RR – Recoilless Rifle
 RRF – Radar Rangefinder
 RS – Racing Slick
 SAM – Surface-to-Air Missile
 SB – Steelbelted
 SCs – Super-Carburetors
 SD – Spikedropper
 SG – Spike Gun
 SKD – Smoke Discharger
 SL – Starshell Launcher
 SMD – Spear 1000 Minedropper
 SMG – Submachine Gun
 SP – Smoke Projector
 SR – Super Rocket
 SS – Smokescreen
 StG – Shotgun
 SWC – Single-Weapon Computer
 T – Top
 TB – Top Back
 TDX – Two-Dimensional Explosive
 TF – Top Front
 TG – Tank Gun
 TG(n) – Larger Tank Gun
 TGD – Tear Gas Discharger
 TL – Targeting Laser
 TML – Tripod Missile Launcher
 TPC – Tank Personnel Carrier
 TS – Tread Skirts
 TwL – Twin Laser
 U – Underbody
 UB – Underbody Back
 UF – Underbody Front
 URGL – Under-Rifle Grenade Launcher
 URGS – Under-Rifle Gyroslugger
 VFRP – Variable-Fire Rocket Pod
 VLAW – Very Light Anti-Tank Weapon
 VMG – Vulcan Machine Gun
 VS – Vehicular Shotgun
 WGM – Wire-Guided Missile
 WGT – Wire-Guided Torpedo
 WPS – Weight per Shot
 WStab – Weapon Stabilizer
 XL – X-ray Laser



M-C006 "Owl"

Length: 7'
Width: 2' 8"
Height: 4' 8"
Mass: 1,225 lbs.
Top Speed: 172.5 mph

Cost: \$36,040
Function: Recon
Manufacturer: Jupiter Electronics
In Service: U.S. Army, USMC

The Owl is silent, a whisper on the breeze. Its highly-touted Stealth option works quite well; with good camouflage, the Owl is practically invisible. Its high-tech gadgets make it unpopular with maintenance personnel, but the fact that it has an actual cargo box (large enough for a nice lunch, or a couple of spare magazines) is appreciated by the cycle scouts who use it. (Some of these cycles have been "lost" from government inventory and are used by border-runners. The cargo box is just right for contraband.)

Construction: Heavy Cycle, Super Power Plant with PCs and SCs, OR suspension, OR Puncture-Resistant Tires, Cycle Windshell.

Crew and Cargo: Driver. 1/2 space/20 lbs. cargo.

Equipment: Computer Navigator, Heavy-Duty Shock Absorbers, Hazard Detector, IFF, IR Shielding, IRSS, Military Radio, Radar, Radar Detector, Stealth, Telescopic Optics, Thermograph, Vehicular Camera, Vehicular Computer.

Armament: None.

Concealment: None.

Armor: Radar-Proof Armor: F10, B10. RP 10-point Cycle Windshell. RP 10-point wheelguards.

Handling: Acceleration 10, HC 1(2 off-road), Top Speed 172.5 mph.

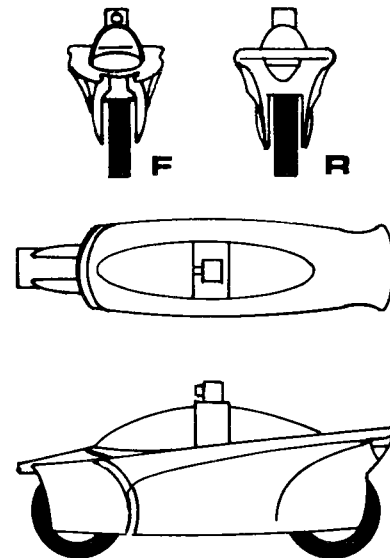

M-CSU40 "LaForge"

Length: 7'
Width: 1' 5"
Height: 2' 10"
Mass: 1,300 lbs.
Top Speed: 125 mph

Cost: \$133,800
Function: Recon
Manufacturer: Harley-Hughes
In Service: U.S. Army

The LaForge is the state-of-the-art, when it comes to cycle electronics. It's a perfect example of dedicated sensors meeting classic American motorcycle frame engineering – meaning that it's not a "crotch-rocket," a lay-down bike. Its lack of a radar-shielding windshell and its low speed make it seem less impressive than the other recon bikes – until the electronics suite is revealed. Few motorcycles are capable of providing their own ECM, either to cover their own activities or as ECM support for other forces.

Construction: Heavy Cycle, Medium Power Plant with PCs and SCs, OR suspension, OR Puncture-Resistant Tires.

Crew and Cargo: Driver. No cargo.

Equipment: Computer Navigator, Heavy-Duty Shock Absorbers, Hazard Detector, IFF, IR Shielding, IRSS, Military Radio, Military Radar Jammer, Radar Detector, Sound Enhancement, Stealth, Telescopic Optics, Thermograph, Vehicular Computer.

Armament: None.

Concealment: None.

Armor: F5, B5.

Handling: Acceleration 10, HC 1(2 off-road), Top Speed 125 mph.

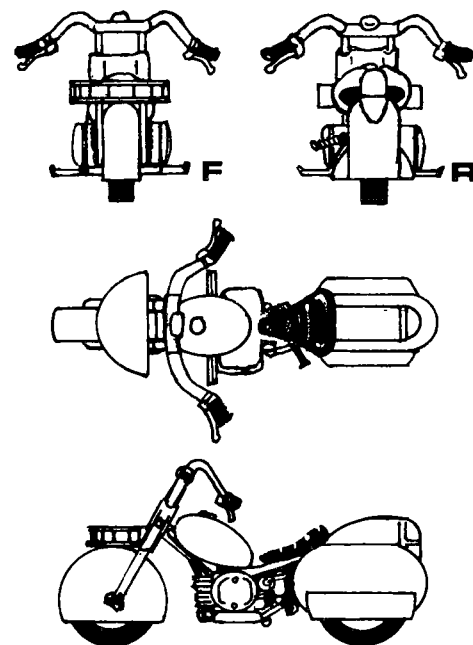

Military trucks are usually called almost anything except “trucks.” Usually the only “truck” on a post is the ball at the top of the flagpole. The most popular term for military trucks is “transport, cargo,” or “transport, general purpose.”

Civilian trucks are much more heavily-armed than any but the most special-purpose military trucks. If you see a military truck that sports as many guns as a civvie eighteen-wheeler, then it’s probably a standard civilian rig in military service. Buying civilian-spec road vehicles is Standard Operational Procedure with almost every military organization; they’re good enough for the road, so why not military service? Special military-grade trucks are only constructed for off-road service, an environment hostile to civilian trucks.

Military organizations also use a great many trailers; if you have an off-road vehicle with some extra power left over, hitch a trailer to it! These are typically normal car trailers, usually with Off-Road solid tires and Extra-Heavy suspensions, 2 to 4 points of Laser-Reflective Metal armor and no weapons. Trailers are used for cargo, ammunition transport, mine-laying (with minedroppers), fuel, water, and even troop transport. Some are outfitted with communications facilities and used as command trailers.

M-73A “Two-Ton” Cargo Transport

Length: 17’ 6”

Width: 7’ 1”

Height: 8’ 9”

Mass: 9,695 lbs. (unloaded)

Top Speed: 115 mph

Cost: \$109,662.50

Function: Transport

Manufacturer: Various

In Service: Ubiquitous

The “Trey-Eight” or “Two-Tonner” is one of the most widely-used vehicles in military service. The original design dates back to the 20th-century Electric Vehicle Project, where the U.S. military started looking into “green” alternatives to gas-powered vehicles. When the design was perfected, it was licensed to several truck manufacturers. Through mergers, corporate takeovers and contract renegotiations, almost every vehicle manufacturer now has the contract to legally manufacture M-73A transports.

The M-73A is nothing more than a lightly-armored, ten-wheeled, off-road truck with cargo capacity, benches for troops, and a single M2A2 Heavy-Barrel machine-gun mounted over the cab. This simplicity makes it popular with every military organization, and even with civilian operators needing off-road cargo trucks.

Construction: Cab-over Ten-wheel Truck, Van Carrier, Standard Chassis, Military Off-Road Suspension, Small Truck Power Plant with PCs and SCs, OR Truck Solid Tires.

Crew and Cargo: Driver, Gunner, Cargo/Passengers 29 spaces/5,305 lbs.

Equipment: Assault Ramp on carrier, Computer Navigator, Extra-Heavy Trailer Hitch, Fire Extinguisher, Heavy-Duty Brakes, Heavy-Duty Shock Absorbers, Hazard Detector, IFF, Light Amplification, Military Radio, Radar Detector, Sun Roof, Winch.

Armament: Pintle-Mount HMG on cab.

Concealment: None.

Armor: LR Metal Armor: Cab F3, R3, L3, B2, T3, U3. Carrier F0, R2, L2, B2, T0, U2.

Handling: Truck Acceleration, HC 1 (2 off-road), Top Speed 115 mph (loaded).

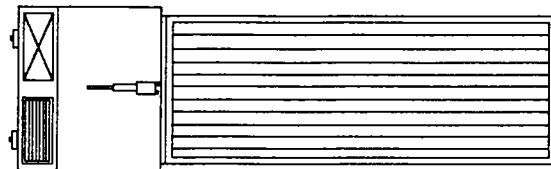
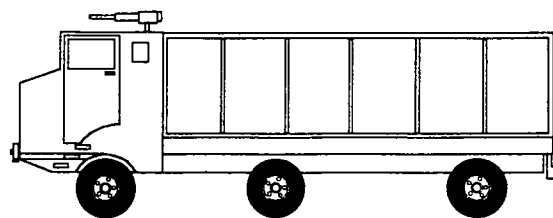
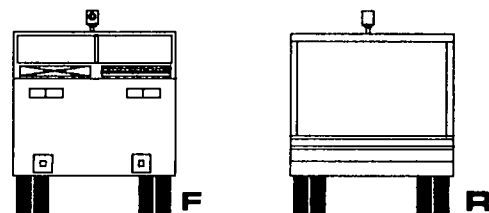

HELICOPTERS

The helicopter was a military development from its inception nearly a century ago. It was the answer to the problem of large airfields and aerial travel – how to get the speed of aerial travel without having to have a large airfield waiting at the end of the flight? The vertical take-off and landing capabilities of the helicopter answered the problem perfectly.

Not 20 years after their first appearance helicopters became the staple of swift troop movement and deployment. In the middle of the Vietnam War, a new development surfaced: the helicopter gunship, at first a normal machine with tacked-on weapons, then a specialty machine built to support troops. With its slow speed and loiter time, helicopters could precisely hit troop targets that the high-speed jets of the time missed.

Helicopters swiftly evolved into the familiar forms they occupy today: attack, transport, recon, medivac. With the advent of plasticizer armor, they acquired enough protection to actually take a hit from AA weapons and survive. They still have to operate at the most dangerous altitude level. Helicopters live at NOE – where one wrong move means disaster, and a bewildering array of anti-aircraft weapons are present to work against them.

Still, no military is complete without its helicopters.

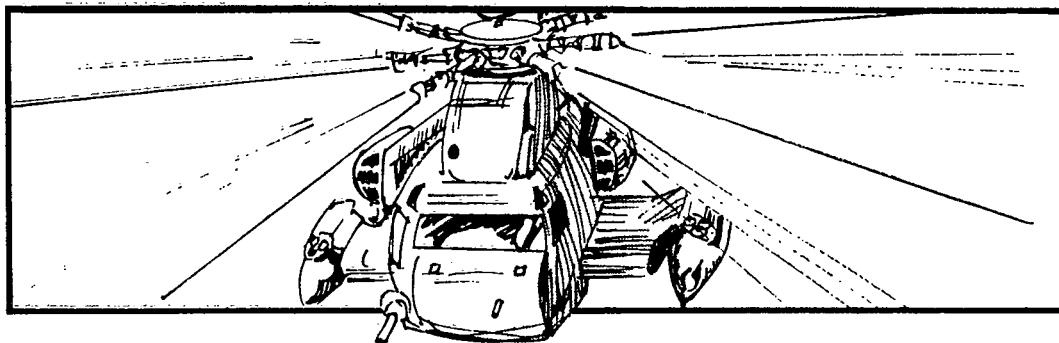

M-RHD "Robot"

Length: 11' 3"

Width: 5' 1"

Height: 9' 7"

Mass: 4,484 lbs.

Top Speed: 187.5 mph

Cost: \$74,136

Function: Recon

Manufacturer: MDDH Industries

In Service: U.S. Army, National Guard,
U.S. Navy,
Oklahoman Corporates

"Robot" is an uninspired name, but appropriate, since it's an uninspired helicopter. The Robot is a simple, serviceable, effective RPV (remotely-piloted vehicle) surveillance drone with the added usefulness of "break-down" capability; the machine can be disassembled into sections and carried in a truck. Because of the low price tag and easy availability, the Robot can be found nearly anywhere. TV companies even use them to cover heavy-fire events where manned machines would be at too much risk.

Construction: One-Man Helicopter, Mini Power Plant, CACR, Remote Control, Streamlined.

Crew and Cargo: No crew, no cargo.

Equipment: Hazard Detector, IFF, Image Enhancement, IRSS, IR Shielding, Military Radio, Radar, Radar Detector, Radar Jammer, Rotor Camera with IR and tuned TL, Telescopic Optics, Terrain-Following Radar, Thermograph.

Armament: None.

Concealment: None.

Armor: Radar-Proof Armor: F20, L15, R15, B15, T10, U23. Rotor DP 3/3.

Handling: Acceleration 5, HC 0, Top Speed 187.5 mph.

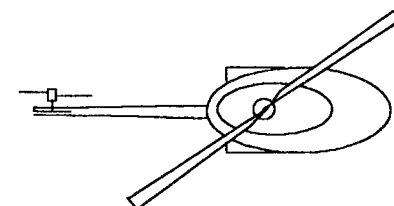
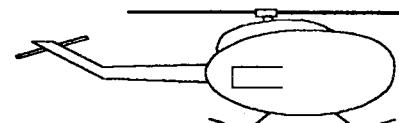
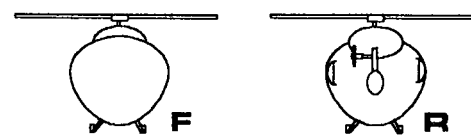

STUCK FOR AN ADVENTURE? NO PROBLEM.

**e23 sells high-quality game adventures
and supplements in PDF format.**

- Get complete sample adventures free for *GURPS*, *In Nomine*, and *Traveller*!
- PDFs from the major players in online publishing: Ronin Arts, Ken Hite, Atlas Games, and 01 Games.
- New gems from up-and-coming publishers, like Atomic Sock Monkey Press and Expeditious Retreat Press.
- Digital editions of out-of-print classics, from *Orcslayer* and the complete run of *ADQ* to *GURPS China* and *GURPS Ice Age*.
- Fully searchable files of *GURPS Fourth Edition* supplements.
- Original material for *Transhuman Space* and *In Nomine*, with new *GURPS* supplements from Phil Masters, David Pulver, Sean Punch, and William Stoddard!
- Buy it once, have it always. Download your purchases again whenever you need to.

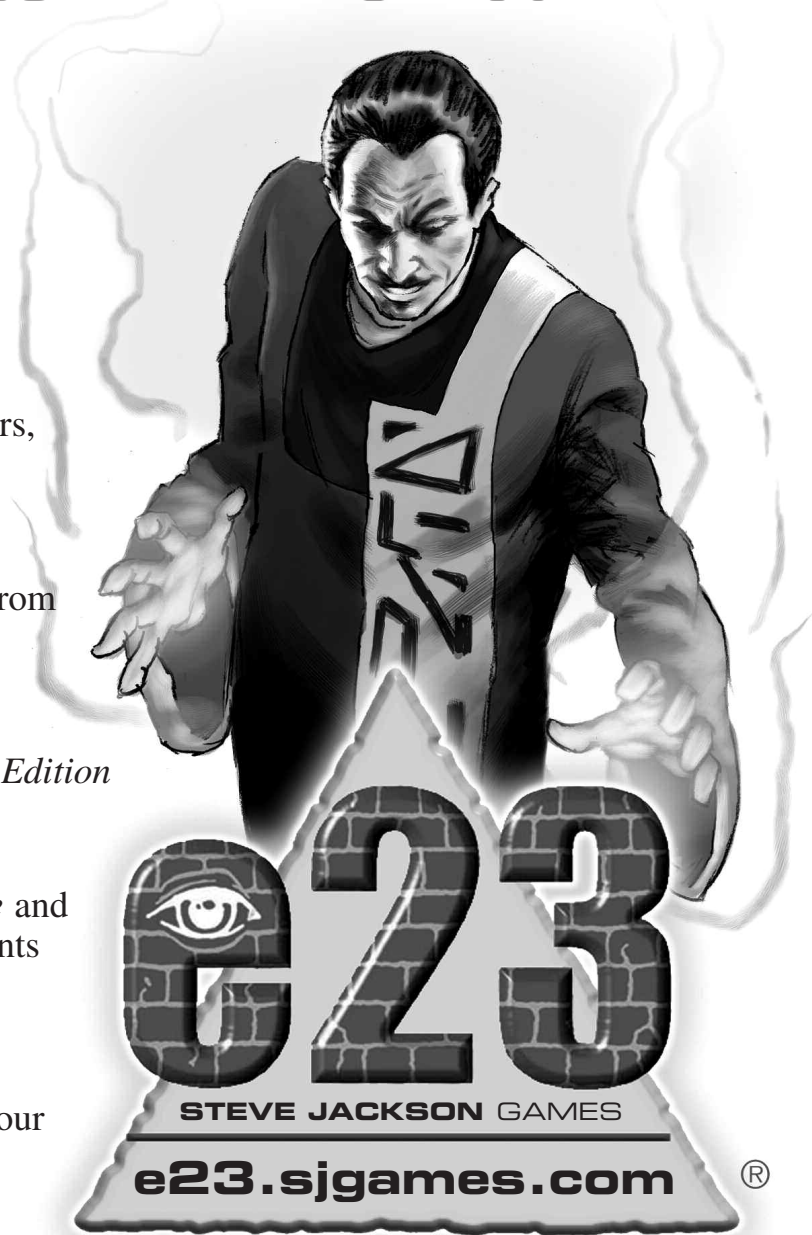

Download ● Print ● Play

STEVE JACKSON GAMES

e23 is part of Warehouse 23, the online store at Steve Jackson Games.
Warehouse 23 is also the official Internet retailer for Atlas Games, Ninja Burger, and many other publishers.
Visit us today at www.warehouse23.com for all your game STUFF!